

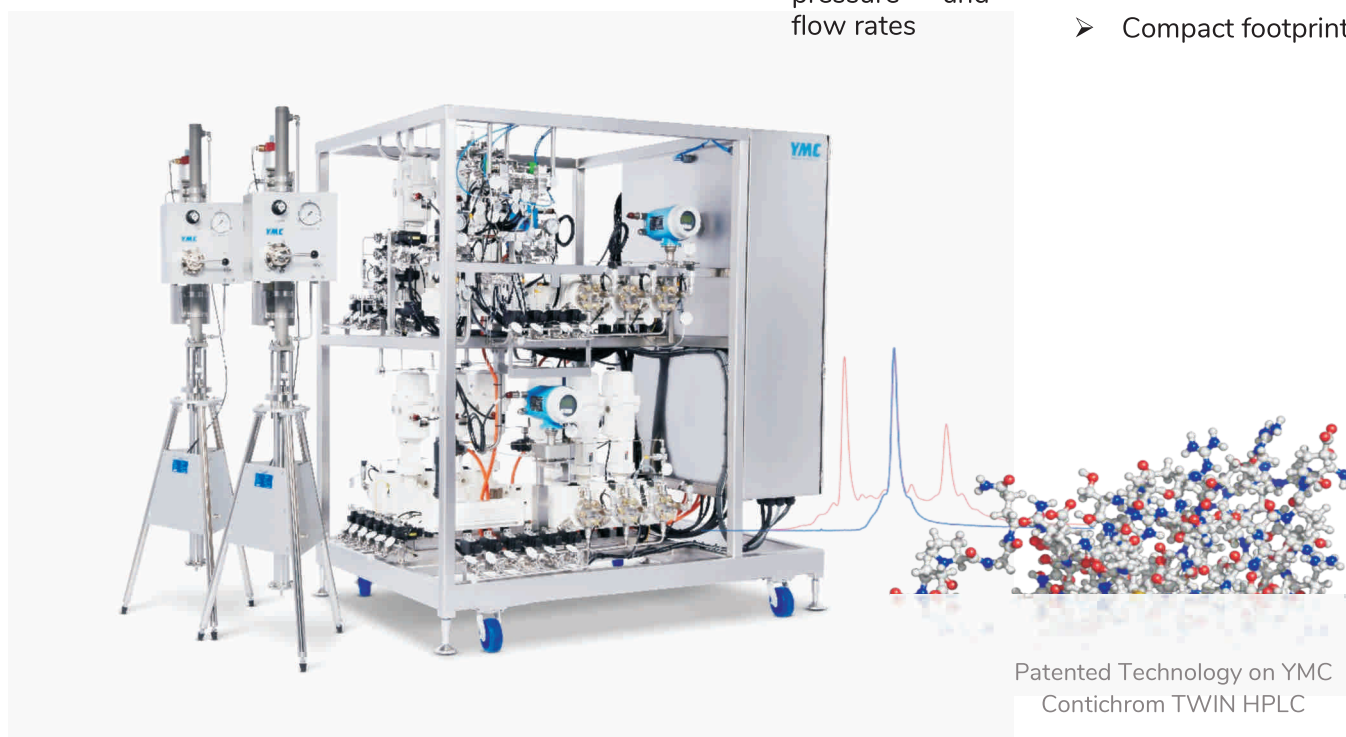

YMC Contichrom[®] TWIN for Peptides & Oligonucleotides

Featuring patented MCSGP* technology for enhanced yield and purity

- Increase yield by up to 30-60%
- Reduce solvent consumption by up to 70%
- Class I Div. II design
- Scale-up / down from Contichrom[®] HPLC bench-top instrument
- Wide range of pressure and flow rates
- Compact footprint



Patented Technology on YMC Contichrom TWIN HPLC



No more compromise – attain both yield and purity

Conventional purification of peptide and oligonucleotides is a trade-off between yield and purity. YMC Contichrom Twin two-column configuration facilitates continuous chromatography for 'tides purification with automatic internal re-cycling and re-separation of overlapping fractions until maximum yield and purity are achieved.

This GMP-ready, easy-to-use chromatography system features the exclusive MCSGP technology developed by YMC ChromaCon AG. Enhance yield by up to 3-fold while maintaining high purity and enjoying up to 70% reduction in solvent and buffer consumption.

*Multi-column Counter-current Solvent Gradient Purification

Benefits of YMC's Contichrom TWIN HPLC / MCSGP

- Reduction in solvents (buffers) by up to 70%
- Improved yield 30-60%
- Process faster, significant increase in productivity
- Simple design to facilitate validation
- Industry-leading high-pressure pumps for maximum flow accuracy and precision throughout a wide gradient range.
- Scale-up/-down from Contichrom® HPLC bench-top instrument
- The YMC EcoPrime Twin HPLC is capable to operate not only the MCSGP but also batch mode. This single system solution allows for ultimate flexibility for manufacturing saving space and capital equipment cost without investing in additional (batch) equipment.

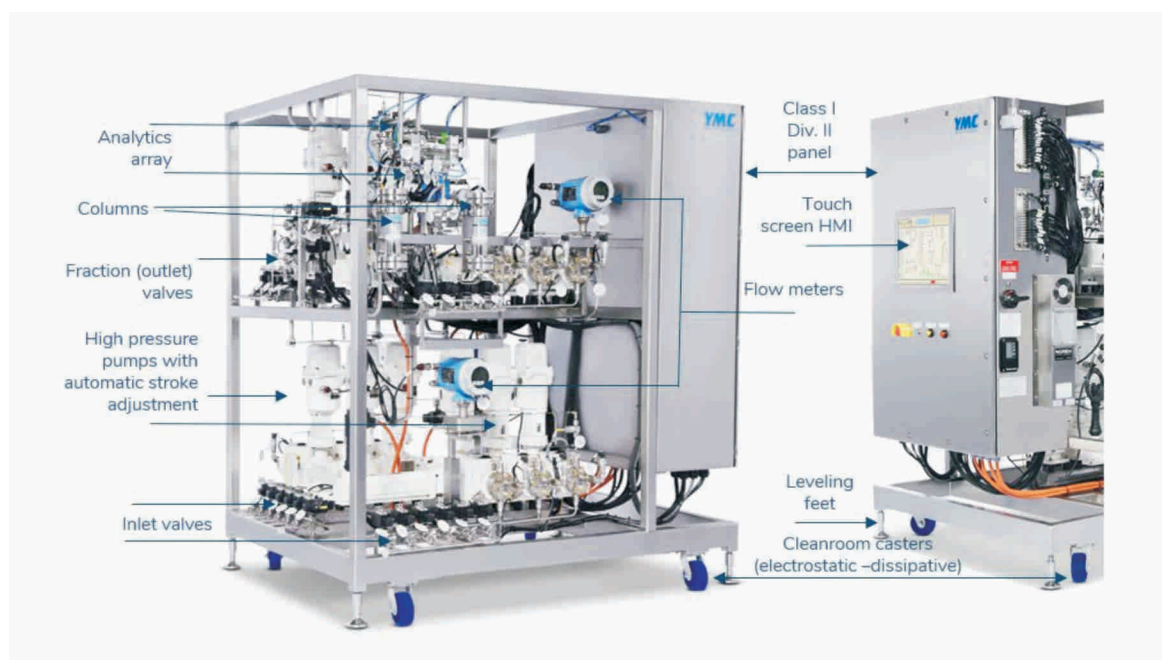

Fig. above: TWIN MCSGP systems are feature rich using highest quality components which are selected for reliability, global availability, safety and ease of compliance.

Multi-column, continuous HPLC increases yield and purity of peptides & oligonucleotides

Pilot and production scale systems for purification of small biotherapeutic molecules.

The opportunity with peptides

Peptides are a highly versatile class of drugs that cover a wide variety of pharmaceutical targets, have high specificity and are generally low in toxicity. A major challenge, however, is that their purification can be difficult, due to weakly or strongly retained impurities overlapping with the product peak. This results in poor yield at the desired purity requiring larger or more numerous batches to generate sufficient quantities.

Conventional chromatographic processes can produce fractions with the desired target purity but often at the expense of yield while at the same time consuming significant quantities of solvents and buffers. The opportunity is to employ an innovative, automated continuous chromatographic approach which eliminates the dilemma of choosing between yield for purity and also provides significant savings in solvent and buffer consumption. The reduction in synthesis batches required with YMC's higher yield purification system is a direct outcome that further enhances ROI.

A new approach to oligonucleotide purification

Single-stranded DNA and RNA oligonucleotides are increasingly being used in a range of areas from clinical diagnostics to new biotherapeutics. While the automated synthesis of oligonucleotides is a rather straight-forward process, purification still presents challenges. Efficient purification of target oligonucleotides depends on their length and often yield is sacrificed to obtain a higher purity fraction. The MCSGP process performed with Contichrom TWIN HPLC enables re-cycling and re-separation of fractions with product purity below

the threshold to obtain a high purity fraction at higher yield.

The Contichrom TWIN HPLC is based on YMC ChromaCon's patented approach to continuous purification. The simple, two-column design is built for use in GMP environments where yield, purity, profitability, and up-time are paramount. It is well suited to transform existing batch processes using your choice of chromatography resin and columns.

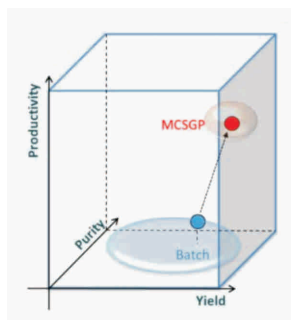

Fig. 1: MCSGP process maximizes both yield and purity over conventional batch

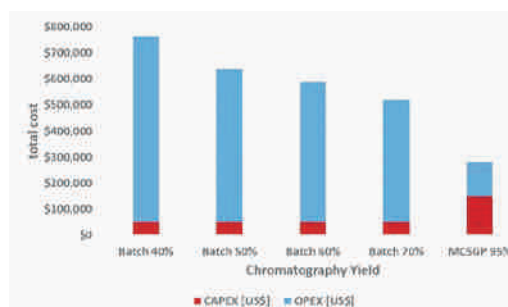

Fig. 2: CAPEX/OPEX of downstream processing of synthetic peptides for batch chromatography with varying yield and for MCSGP obtaining highest yield.

Contichrom TWIN HPLC with MCSGP is used for a variety of purification applications

- synthetic peptides
- oligonucleotides
- ADC's

How it works

The Contichrom TWIN HPLC employs MCSGP (multicolumn counter-current solvent gradient purification), a chromatography process that uses two columns of the same type and internal recycling and automatic re-separation of overlapping side-fractions to elute and recover only product of high purity at a high yield. The ability of MCSGP to recover product in overlapping fractions enables the use of conditions that improve throughput as compared to single-column batch processes.

The increased yield of MCSGP ...

- allows downscaling of the upstream chemical synthesis steps
- improves productivity of the downstream process allowing for use of shorter columns
- reduces solvent consumption
- eliminates the need for re-chromatography
- fewer side-fractions reduces storage and analytical testing needs

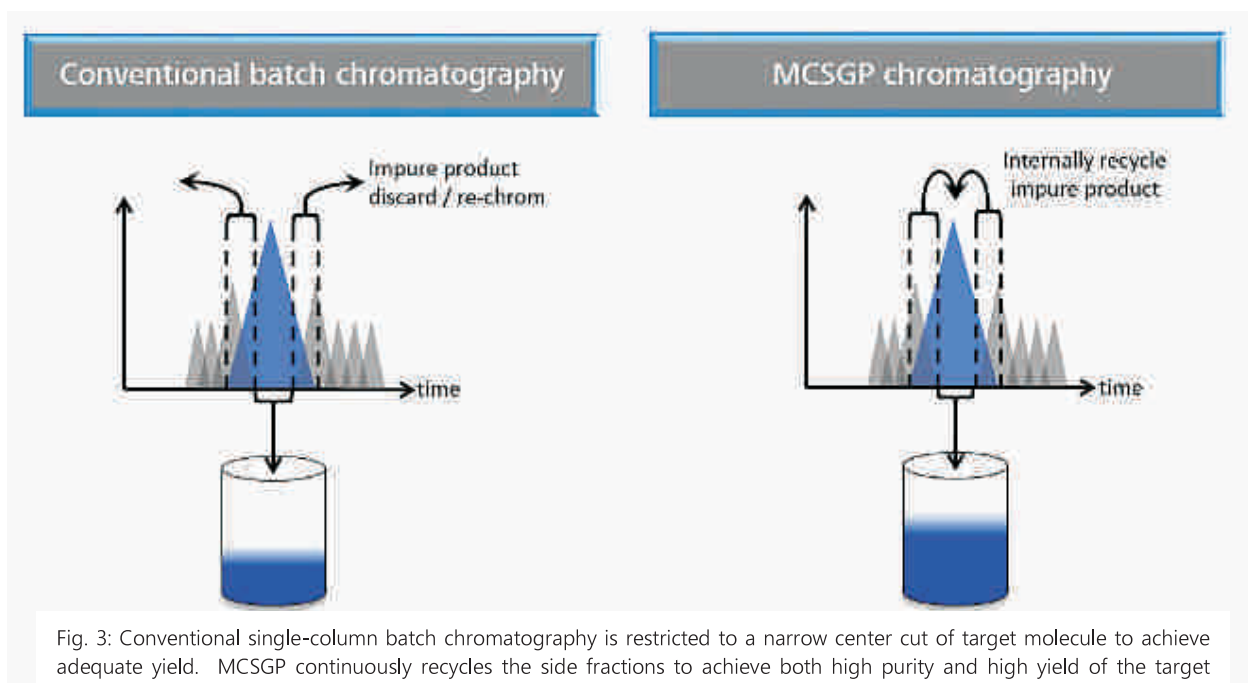

One system, multi-function

This advanced system can be configured to operate in multiple modes: single-column batch, or continuous chromatography thus maximizing its utility in any process development or production environment. The systems' dynamic flow breadth allows the use of a wide range of column diameters and process conditions.

Contichrom TWIN HPLC delivers

- Reduction in solvents and buffers by up to 70%
- Improved yield by up to 3x
- Simple design to facilitate validation
- Industry-leading high pressure pumps for maximum flow accuracy and precision
- Scale-up/-down from Contichrom® HPLC bench-top instrument

Increased productivity, quick payback

The productivity of a Contichrom TWIN HPLC for MCSGP, when placed into service in a modest yield peptide or oligonucleotide facility can increased ROI compared to other HPLC chromatography systems. The yield along with the decrease in solvent consumption provides quick payback.

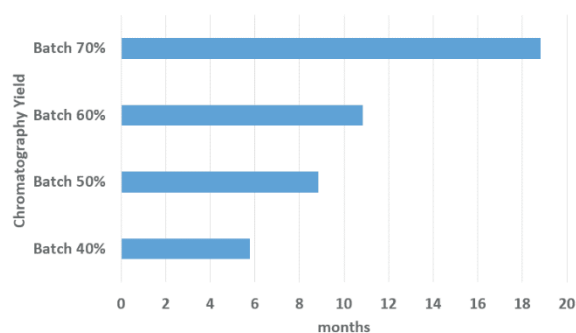

Fig. 4: Payback period for investment in MCSGP compared to batch processes having different yields. Example readout: For a batch yield of 40% the pay-back period for a system with MCSGP function will be 6 months based on the total cost savings assuming a production quantity of 10kg peptide at target purity. When doubling the production amount to 20kg, the pay-back period will be halved.

Simplicity

The simple, two-column design of the Contichrom TWIN HPLC accelerates validation, simplifies maintenance, reduces costly downtime, and minimizes operating expenses. The simple design facilitates implementation in the process development lab or the production suite because the system is easy to understand and use.

System sizes available

YMC offers a range of system capacities to suit small to large production facilities. In addition to our standardized platform YMC can customize the system to a particular need.

*Recommended system flow rate range for MCSGP applications.

Contichrom TWIN HPLC	Flow rate range* (L/h)	Column ID range (cm)	Linear velocity range (cm/h)
100	0.6	40	5
300	2	200	10
500	9.0	500	20

Table above: Contichrom TWIN HPLC for MCSGP dynamic range.

Advanced fluidic design

Designed to meet the demanding requirements of next generation process systems, Contichrom TWIN HPLC consists of digitally-controlled, hygienic pumps that provide industry-leading flow, precision and accuracy at high pressures and wide gradient ranges. The triplex pump configuration delivers nearly pulse-free flow. An optimized system flow path and specially designed multi-port valves deliver extremely low hold-up volume for exceptional chromatographic performance.

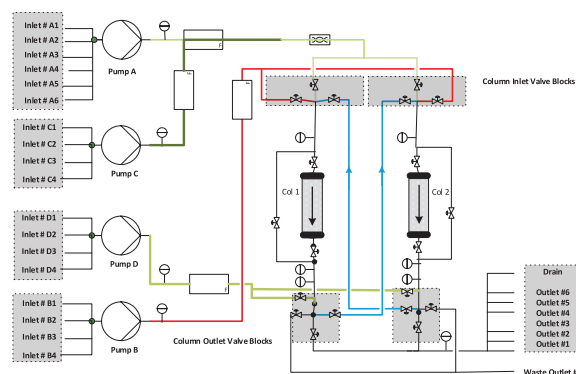

Fig.5: Basic schematic of Contichrom TWIN for MCSGP

Scale up, scale down

A simple tool for scale-up or -down is ChromaCon's Contichrom HPLC instrument (Figure 6) that can be used to develop new processes or optimize existing ones. The Contichrom HPLC is a modular, bench-top instrument for performing MCSGP, single-column batch, integrated two-step processes, N-Rich®, and sequential polish at a smaller scale

(flow 0.1 – 36 mL/min or 0.1 – 100 mL/min, up to 100 bar). Proven ChromIQ software provides enhanced functionality and visualization for continuous, cyclic processes. The industrial Contichrom TWIN GAMP V software has continuity with the ChromIQ lab-friendly software.



Fig. 6: Scale up / scale down is seamless between Contichrom CUBE HPLC (shown left) and Contichrom TWIN HPLC (right) with optional YMC DAC columns

Typical installations

Contichrom TWIN is used in process development, pilot labs and is well suited for full scale production runs. Contichrom TWIN, with its wide dynamic range and multi-functionality, is ideally suited for multi-product environments. The small footprint enables installation in space-constrained facilities.

Quality and regulatory considerations

As with all Contichrom platform equipment, the Contichrom TWIN HPLC system is designed to meet high quality expectations. The design and construction of the equipment meets the following standards, assuring a safe, ergonomic system capable of producing the product within the guidelines of the FDA:

- System designed for GMP operation and validation
- Enables 21 CFR part 11 compliance
- USP Class VI materials and seals

- Digitally controlled metering pumps
- Follows GAMP 5 guidelines
- Class I Div. II

Contichrom TWIN HPLC Software

An information-rich, graphical interface displays system and process information as well as historical trends putting relevant information in one place to facilitate informed decision-making. The main process screen can also be used to manually operate the system to facilitate qualification and troubleshooting.

The Contichrom TWIN HPLC system uses PLC software to control the chromatography process, to acquire data and to provide historical trending. The software provides user configurable control of all chromatographic parameters. The user configurable software is built on Rockwell FactoryTalk® View SE. The system provides recipe management with access control to prevent modification of a recipe by unauthorized users, as well as providing an audit trail for recipe modification. Batch reports are easily generated. YMC also offers custom solutions for users who prefer DeltaV controls.

Options

The base system is feature rich and ready for most modern development or production suites. YMC does offer the following options to enhance the system:

- Additional inlet and outlet (fraction) valves
- Filters
- Pre-Column analytics
- ATEX Zone II
- Sample valves

Development and training

Customers wishing to perform proof of concept evaluations can lease a ContiChrom HPLC instrument. As part of a rental package, YMC will train your technicians on the proper set up and operation at your site. Rentals are typically 4 weeks which allows for experimentation with a variety of conditions and resins. Contact your YMC sales representative for details.

Service

YMC has operations in over 20 countries with local capability in 80 countries with LEWA to troubleshoot pumps. YMC systems include remote access for automation troubleshooting and training (client-enabled). We strive to only use components that are non-proprietary with global distribution for local acquisition. No special tools are required to perform standard maintenance.

Operating Pressure and Temperature

Maximum operating pressure	80 bar
Ambient temperature range	4 – 25 °C
Process temperature range	4 – 65 °C

System Specifications

System - HPLC	Flow rate range*
Contichrom TWIN 100	0.01 – 0.67 LPM
Contichrom TWIN 300	0.03 – 3.33 LPM
Contichrom TWIN 500	0.13 – 8.33 LPM

*Control system flow rate range.

- Dual UV detectors with variable wavelengths (200 to 400 nm).

Systems are typically engineered to fit most industrial entrances. Check with YMC for dimensions and weight.

YMC offers many complimentary products and services for peptide and oligo separation and purification.

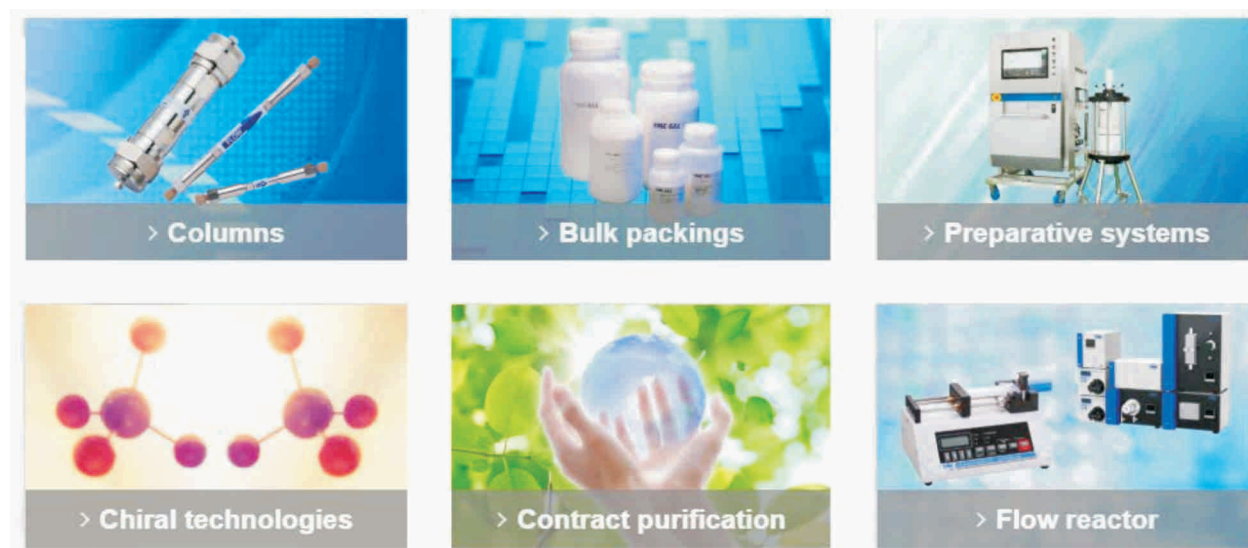

It starts here – the Contichrom CUBE



This is our flagship FPLC bench-top system. It offers unique capabilities for mastering complex separation challenges by using our proprietary processes. The user-friendly software automates the use of these processes.

- Standard batch processes
- Automated two-step batch processes with in-line dilution
- Automated processes for continuous capture (CaptureSMB)
- AutomAb dynamic process control for keeping the CaptureSMB process at an optimum
- Automated cyclic polishing process (MCSGP) for difficult separation challenges
- Mcontrol (AutoPeak) dynamic process control for keeping the MCSGP process at an optimum
- Automated cyclic enrichment process (N-Rich) allowing to enrich and isolate product-related impurities
- Various accessories available

Ordering information

To order the Contichrom TWIN HPLC or LPLC systems, please contact your regional sales representative.

YMC (India) Private Limited
Head Office : A-154-155, 1st Floor, Eros Boulevard,
Hotel Crown Plaza, Mayur Vihar Phase-1,
New Delhi - 110091
Contact No : 011-45041601/701
E-mail : sales@ymcindia.com

YMC Process Technologies
Bio/Pharma Systems' Group
8 Charlestown Street
Devens, MA 01434
Tel: +1 978 487 1100
www.ymcpt.com
sales@ymcpt.com

Headquarters: YMC Co., Ltd.
YMC Karasuma-Gojo Building
284 Daigo-cho, Karasuma Nishiiru,
Gojo-dori,
Shimogyo-ku, Kyoto, 600-8106 Japan
Tel: +81-75-342-4515
FAX: +81-75-342-4550
www.ymc.co.jp
sales@ymc.co.jp

YMC logo and EcoPrime are trademarks of YMC Co. Ltd.

ChromaCon, Contichrom, ChromIQ, Mcontrol, AutoPeak and CaptureSMB are registered marks of YMC ChromaCon AG.

Rockwell FactoryTalk is a registered mark of Rockwell Automation. LEWA ecodos is a mark of LEWA GmbH. DeltaV is a registered mark of the Emerson Process Management family of companies.

All goods and services are sold subject to the terms and conditions of sale of the company within YMC which supplies them. A copy of these terms and conditions is available on request. Contact your local YMC representative for the most current information. Subject to change without notice. Data herein does not constitute a guarantee of performance. © 2020 YMC Process Technologies. – All rights reserved.